

The Drive & Control Company

Rexroth
Bosch Group

Rexroth VFC & EFC Frequency Converter

New VFC 5610 up to 185Kw
(Heavy-duty)
New EFC 5610 up to 160Kw
(Heavy-duty)



Overview

VFC 3210

Rexroth VFC 3210 with enhanced V/f control, covering the power range from 0.4 to 4 kW, is a multifunctional mini type frequency converter. It is widely used in the fields of woodworking machinery, packaging machinery, food processing and HVAC due to its characteristics like side by side mounting, smaller depth than VFC 3610, free cooling (up to 1.5 kW), built-in PID, multi-speed control and torque compensation etc.

VFC 3610 & 5610

Rexroth VFC 3610 & 5610 series has been especially developed to meet the requirements of emerging markets. VFC 3610 is an enhancement solution for small machinery application as well as other V/f application. With the power output range of 0.4...22 kW, start-up torque of 1.5 Hz/100 % and 3 Hz/150 %, Heavy-duty/ Normal duty etc. features, VFC 3610 is widely used in fan, water pump, materials transmission, mixing equipment, HVAC, textile and wooding machinery.

VFC 5610 is a high performance vector frequency converter for high end machinery applications. With the power range of 0.4...185 kW, start-up torque of 0.5 Hz/200 %, torque control or speed control options, high control accuracy and fast response etc. features, VFC 5610 serves for industry mixer, CNC machine, extruding equipment, machine tool, food packing and printing industries.

EFC 3610 & 5610

The Rexroth EFC 3610 & EFC 5610 are the series for the worldwide market. They comply with all major certification standards, such as CE, UL, cUL, RCM, EAC ,TÜV and RoHS. EFC 3610 & 5610 not only have VFC 3610 & 5610 Functions, but also have additional series of functions.

- ▶ Synchronous motor control(EFC5610), which improves accuracy and reduces energy consumption.
- ▶ Built-in EMC C3 mains filter to reduce EMI.
- ▶ Designed for up to 45 °C ambient temperature without derating.
- ▶ STO function reaching SIL3 level is realized in standard EFC 5610.
- ▶ Built-in DC reactor for EFC5610 30 kW and above.
- ▶ In addition to PROFIBUS DP and CANopen like VFC, EFC also supports ERCOS III, PROFINET IO, Ethernet IP, Modbus TCP, Ether-CAT. And the speed of its unique SERCOS III could reach microsecond.



Technical Details

			VFC 3210	VFC 3610	VFC 5610	EFC 3610	EFC 5610
Input	1P 200 VAC	Rated output power	0.4...2.2 kW				
		Mains voltage	200...240 V ± 10 %				
		Supply frequency	50/60 Hz ± 5 %				
	3P 400 VAC	Rated output power	Heavy-duty: 0.4...4 kW	Heavy-duty: 0.4...22 kW Normal-duty: 7.5...30 kW	Heavy-duty: 0.4...185 kW Normal-duty: 7.5...200 kW	Heavy-duty: 0.4...22 kW Normal-duty: 7.5...30 kW	Heavy-duty: 0.4...160 kW Normal-duty: 7.5...200 kW
		Mains voltage	-15 % 380 V...480 V ± 10 %				
	Supply frequency	50/60 Hz ± 5 %					
Output	Output frequency		0...400 Hz				
	Control technology		V/f		V/f, SVC	V/f	V/f, SVC
	Motor type		Asynchronous motors				Asynchronous motors, Permanent magnet motors
Functions	Overload capacity		150 %, 60 s	Heavy-duty: 150 %, 60 s Normal-duty: 120 %, 60 s		Heavy-duty: 150 %, 60 s; 200 %, 1 s Normal-duty: 120 %, 60 s	
	Mains filter		-		≥110 kW C3	C3	
	built-in DC reactor		-		≥110 kW	-	≥30 kW
	Frequency resolution		2...12 kHz	1...15 kHz (0.4...22 kW); 1...12 kHz (30 kW及以上)			
	Speed regulation range		1:50	1:50	1:200	1:50	1:200
	Start-up torque		3 Hz 150 %	3 Hz 150 %	0.5 Hz 200 %	3 Hz 150 %	0.5 Hz 200 %
			1.5 Hz 100 %	1.5 Hz 100 %		1.5 Hz 100 %	
	PID control		1				
Control panel type		Fixed LED	Standard detachable LED and optional detachable LCD				
I/O terminals	Analog input	+10 V	✓				
		+5 V	-	✓			
		AI1	0(2)...10 V/0(4)...20 mA				
		AI2	-	0(2)...10 V/0(4)...20 mA			
	Analog output	AO1	0(2)...10 V	0(2)...10 V/0(4)...20 mA			
	Digital input	+24 V	50 mA	max. 100 mA			
		DI1...DI4	NPN terminal, 24 VDC, 8 mA/12 VDC, 4 mA	PNP/NPN terminal, 24 VDC, 8 mA/12 VDC, 4 mA			
		DI5 (Pulse input)	-	PNP/NPN terminal, 24 VDC, 8 mA/12 VDC, 4 mA; Maximum pulse input 50 kHz			
	Digital output	DO1	Open collector output	-	Pull-up/pull-down, 30 VDC, 50 mA		
			Pulse output	-	max. 32 kHz		
Relay output	RO1 (Ta, Tb, Tc)	250 VAC, 3 A/30VDC, 3 A					
Communication		Modbus RTU					
Extension Card	I/O card		-	4DI, 1AI, 1AO, 1OC, 1 relay output			
	Relay card		-	4Relay outputs, 250 VAC, 3 A/30VDC, 3 A			
	Communication card		-	PROFIBUS DP, CANopen	PROFIBUS DP, CANopen, SERCOS III, PROFINET IO, Ethernet IP, Modbus TCP, EtherCAT		
Ambient conditions and certificates	Ambient temperature		-10...40 °C; 40...50 °C, derating 1.5 %/1 °C			-10...45 °C; 45...55 °C, derating 1.5 %/1 °C	
	Humidity		≤90 %				
	Altitude		1000 m; 1000...2000 m, derating 1 %/100 m	1000 m; 1000...4000 m, derating 1 %/100 m			
	Protection category		IP20				
	STO		-				SIL3
Certificate		CE	CE, EAC		CE, UL, cUL, RCM, EAC, TÜV, RoHS		

VFC 3210

Rexroth has always been paying great efforts in deeply understanding the Chinese demands and characteristics so as to keep up with the market development in China. Therefore, aiming at providing simple OEMs with simple, reliable and cost-effective solutions in drives and controls, VFC 3210, one multifunctional mini type frequency converter is designed specifically for Chinese users.

To supply with better products and services, VFC 3210 with V/f control in compact design, offers the output power from 0.4 to 4 kW, supports side by side mounting, and has removable fan and obtains CE certificate, which thus shows a powerful product with safety, reliability and easy operation.

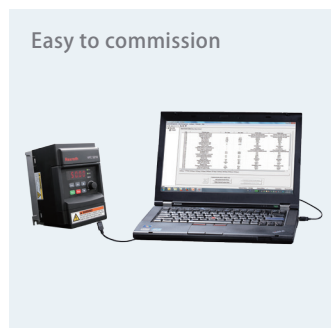

Smart & Delicate

- ▶ Nearly 30 % decrease in depth than 3610 to better adjust to customer installation requirements.
- ▶ A super mini type in compact design.
- ▶ Side by side mounting.

Superior performance

- ▶ The high starting torque of 150 % 3 Hz and 100 % Hz 1.5.
- ▶ Over-excitation control to reduce the braking time.
- ▶ The capacity overload of 150 % 60 s.
- ▶ Modbus RTU is standard.
- ▶ PC software and firmware updates (via Mini-USB port).

Easy to operate

- ▶ Built-in LED operating panel.
- ▶ Easy to operate and maintenance, removable fan, free cooling (not more than 1.5 kW).
- ▶ Structured parameter group for convenient commissioning.
- ▶ Automatic speed limiting and capture.

Stable & Reliable

- ▶ Systematic safety standard and reliability test system.
- ▶ Complete converter protection (phase failure, interphase short circuit, the earthing short circuit, overcurrent, overvoltage, under-voltage, overload, overheat and overheating protection for motors).
- ▶ Reinforced coating of circuit boards for dust-proof and anti-corrosion.

VFC 3210 Block Diagram

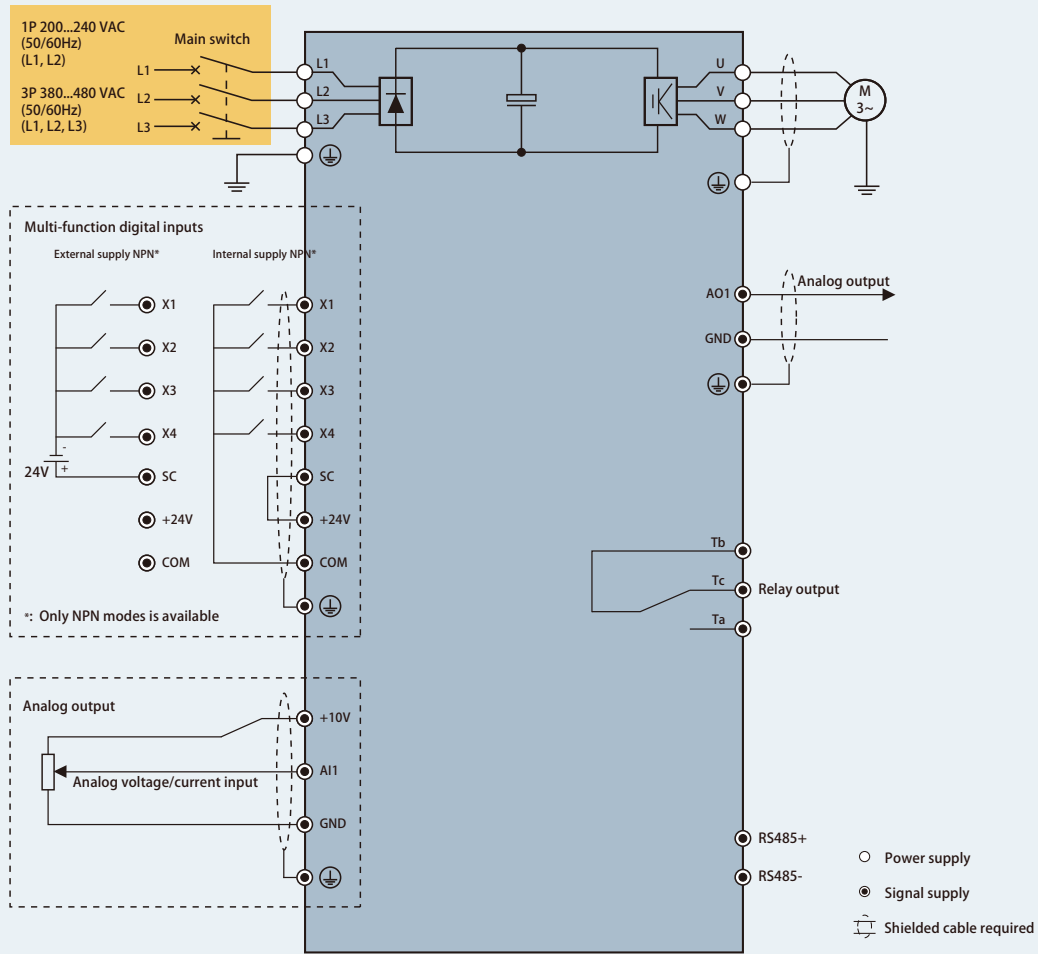

Mechanical Data

	Type VFC & EFC	Rated motor power[kW]	Rated continuous current [A]	W [mm]	w [mm]	H [mm]	h [mm]	D [mm]
		Heavy duty	Heavy duty					
1P 200 VAC	0K40-1P2-MNA	0.4	2.4	90	80	146	125	105
	0K75-1P2-MNA	0.75	4.1	95	85	156	135	120
	1K50-1P2-MNA	1.5	7.3	95	85	196	175	125
	2K20-1P2-MNA	2.2	10.1	120	110	221	200	130
3P 400 VAC	0K40-3P4-MNA	0.4	1.3	95	85	156	135	120
	0K75-3P4-MNA	0.75	2.3					
	1K50-3P4-MNA	1.5	4.0	120	110	221	200	130
	2K20-3P4-MNA	2.2	5.6					
	4K00-3P4-MNA	4.0	9.7					

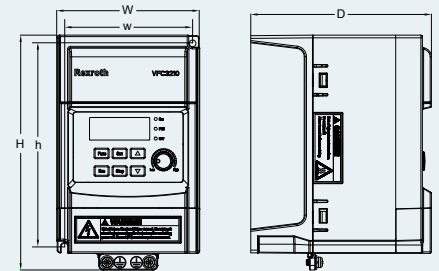

MNA=No built-in EMC filter

VFC 3610 & 5610

Demands of emerging markets and especially focus on its market development and characteristics Rexroth VFC 3610 is an enhancement frequency converter for small machinery application as well as other V/f application, the power output range of 0.4...22 kW(Heavy-duty), and VFC 5610 is a high performance vector solution for machinery application with high demands, the power output range of 0.4...185 kW(Heavy-duty).

VFC 3610 & 5610 series frequency converters have outstanding features with compact size, widely voltage range, low voltage ride-through, side by side mounting, over-excitation brake, and also got CE certificates, provides best solution and service for Chinese customer.



Quick connectors



Bluetooth Adapter



Side by side mounting



DIN rail mounting

Compact design

- ▶ Modularized design
- ▶ Side by side mounting capability to save cabinet space.
- ▶ DIN rail mounting (up to 7.5 kW) for flexible installation.
- ▶ Up to 1.5 kw, no cooling fan; above 1.5 kw, a detachable cooling fan designed to improve the cooling efficiency.

Easy to use

- ▶ Standard equipped LED pluggable, optional equipped LCD pluggable.
- ▶ Bluetooth Adapter optional for easy connection by mobile.
- ▶ Quick Start Menu for easy commissioning.
- ▶ Removable panel, supports remote operation and parameter copy.
- ▶ Quick connectors for I/O terminals to easy installation and maintenance.
- ▶ Integrated brake chopper (up to 22 kW).
- ▶ Fans can be cooled down without removing.
- ▶ Wiring by PNP/NPN.

Powerful

- ▶ Normal duty/heavy duty operation.
- ▶ VFC 5610 110 kW and above have built-in DC reactor
- ▶ High performance vector and torque technology (VFC 5610).
- ▶ Low frequency oscillation suppression and start with speed capture.
- ▶ Inversion forbidden, low voltage ride-through and swing frequency function.
- ▶ Stand-by mode, counter function and energy savings calculator.
- ▶ Pulse input (50 kHz) and pulse output (32 kHz).
- ▶ Over-excitation braking, to reduce braking times up to 50 %.
- ▶ 24 V auxiliary power output for external devices, max. 100 mA (up to kW); max. 200 mA (30...90 kW).
- ▶ Build-in Modbus RTU, option cards for PROFIBUS DP, CANopen, I/O and relais terminal.
- ▶ ConverterWorks for fast commissioning and software update (via Mini USB).

EFC 3610 & 5610

The Rexroth EFC 3610 & 5610 series has been developed for the worldwide market. With the relevant certifications of CE, UL, cUL, RCM, EAC TUV, RoHs, etc., consolidated sales and service is provided worldwide.

The power output range of EFC 3610 is 0.4...22 kW (Heavy duty), and the power range of EFC 5610 is 0.4...160 kW (Heavy duty). The EFC series shares the parameter structure, dimensions and connections with VFC series as well as many functions, EFC series contains several enhanced features such as synchronous motor control (EFC 5610), built-in EMC filter, and multi-Ethernet communication to satisfy worldwide customer more application demands.



Synchronous Motor Drives

- ▶ Except asynchronous motor, EFC 5610 has the capability of synchronous motor drives to improve the control accuracy and reduce energy consume.

Built-in mains filter

- ▶ Complies with EN61800-3 category C3 requirements and reduces electromagnetic interference on the power grid.
- ▶ Shielding motor cable length: 15m (up to 4 kW), 30 m (5.5...18.5 kW), 50m (30...90 kW), 75 m (110...132 kW)
- ▶ EMC filter can be disconnected by EMC screw for use in environments that require especially low leakage currents.

Built-in DC Reactor

- ▶ Built-in DC reactor of EFC 5610 30 kW and above EFC 5610 30 kW.

Safety Torque off(STO)

- ▶ Class 0 cutoff refers to EN60204-1 standard, and got SIL3 certificate.
- ▶ Frequency converter false tripping prevent for operation and maintenance safety.

Up to 45 °C ambient temperature without derating

- ▶ The EFC series can be used in up to 45 °C ambient temperature (VFC 40 °C) without a reduction of output power.

Additional communication options

- ▶ In addition to PROFIBUS DP and CANopen also a SERCOS III, PROFINET IO, Ethernet IP, Modbus TCP, EtherCAT are available. Especially, the Rexroth exclusive SERCOS III communication function Communication rate could be microsecond level.

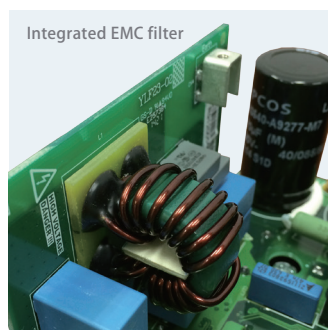

VFC 3610 & 5610, EFC 3610 & 5610 Block Diagram

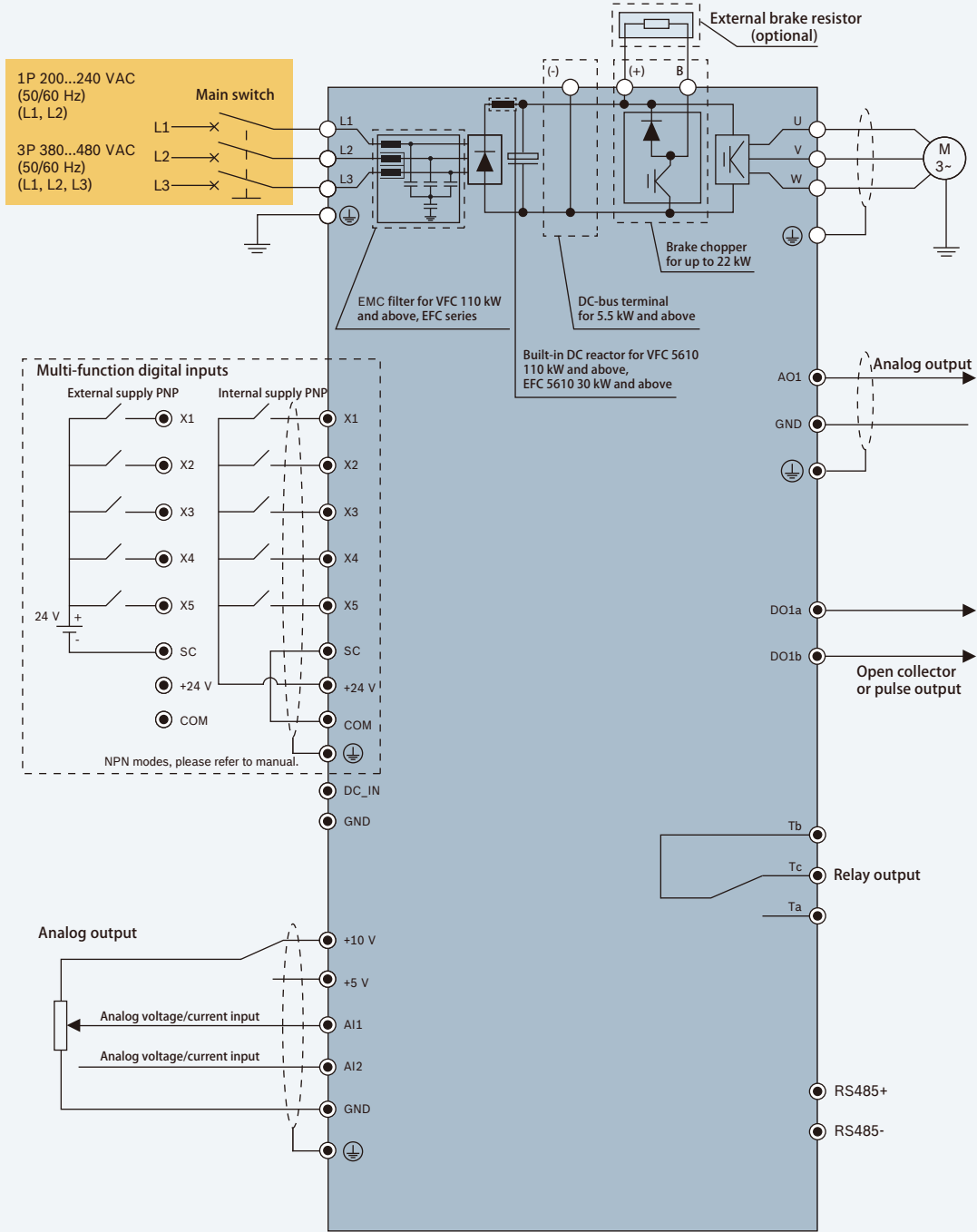

○ Power supply

● Signal supply

⎓ Shielded cable required

VFC 3610 & 5610, EFC 3610 & 5610 Mechanical Data

	Type VFC & EFC	Rated motor power[kW]		Rated continuous current [A]		W [mm]	w [mm]	H [mm]	h [mm]	D [mm]
		Heavy duty	Normal duty	Heavy duty	Normal duty					
1P 200 VAC	0K40-1P2-MxA-xx	0.4	-	2.4	-	95	66	166	156	167
	0K75-1P2-MxA-xx	0.75	-	4.1	-					
	1K50-1P2-MxA-xx	1.5	-	7.3	-	95	66	206	196	170
	2K20-1P2-MxA-xx	2.2	-	10.1	-	120	80	231	221	175
3P 400 VAC	0K40-3P4-MxA-xx	0.4	-	1.3	-	95	66	166	156	167
	0K75-3P4-MxA-xx	0.75	-	2.3	-					
	1K50-3P4-MxA-xx	1.5	-	4.0	-	95	66	206	196	170
	2K20-3P4-MxA-xx	2.2	-	5.6	-					
	3K00-3P4-MxA-xx	3.0	-	7.4	-	120	80	231	221	175
	4K00-3P4-MxA-xx	4.0	-	9.7	-					
	5K50-3P4-MxA-xx	5.5	7.5	12.7	16.8	130	106	243	228	233
	7K50-3P4-MxA-xx	7.5	11	16.8	24.3					
	11K0-3P4-MxA-xx	11	15	24.3	32.4	150	125	283	265	233
	15K0-3P4-MxA-xx	15	18.5	32.4	39.2					
	18K5-3P4-MxA-xx	18.5	22	39.2	45.0	165	140	315	300	241
	22K0-3P4-MxA-xx	22	30	45.0	60.8					
	30K0-3P4-MxA-xx	30	37	60.8	73.7	250	200	510	492	272
	37K0-3P4-MxA-xx	37	45	73.7	89.1					
	45K0-3P4-MxA-xx	45	55	89.0	108	265	200	585	555	325
	55K0-3P4-MxA-xx	55	75	108	147					
	75K0-3P4-MxA-xx	75	90	147	176	325	200	760	727	342
	90K0-3P4-MxA-xx	90	110	176	212					
110K0-3P4-MxA-xx	110	132	211	253	385	250	923	893	350	
132K0-3P4-MxA-xx	132	160	253	303						
160K0-3P4-MxA-xx	160	185 ¹ 200 ²	303 379 ²	351 ¹ 379 ²	480	400	1030	995	360	
185K0-3P4-MxA-xx ³	185	200	351	379						

► 0.4...37 kW

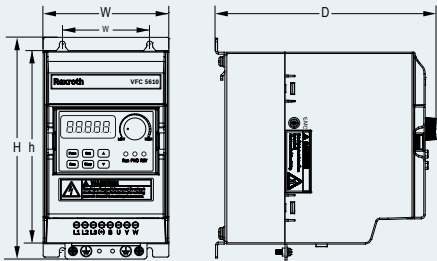

► 45...185 kW

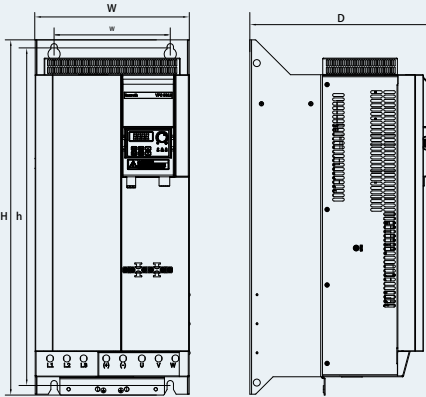

x: MNA= No built-in EMC filter (only apply to VFC) MDA= Built-in EMC filter (only apply to EFC) xx: 7P=Operating panel NN=No operating panel (with Dust cover)

¹: Only apply to VFC, VFC 160 Kw (Heavy-duty) equals 185 Kw (Normal duty) with 351 A output current (Normal duty)

²: Only apply to EFC, EFC 160 Kw (Heavy-duty) equals 200 Kw (Normal duty) with 379 A output current (Normal duty)

³: Only apply to VFC 5610

VFC & EFC 3610 Applications



HVAC

Fans, pumps, air conditioning

Energy savings calculator

- ▶ Keeps track of the achieved energy savings.

Life time reminder

- ▶ Reduces downtime by helping to organize the maintenance schedule.

Speed tracing

- ▶ For smooth catching and restarting of a running fan.

Dry pump protection

- ▶ Automatically detects a dry running pump to protect the equipment.

Pump cascading

- ▶ Use Application Specific Firmware and relay card, 4 maximum pumps could be circularly controlled by frequency converter.



Textile and Dyeing

Heat setting stenter, twister, air-flow spinning

Smart cooling concept

- ▶ Double duct design isolates heat sink and semiconductor to prevent semiconductor from pollution.
- ▶ No cooling fan up to 1.5 kW and detachable cooling fan above 1.5 kW for cotton fiber easy clean.

Import PCBA coating

- ▶ Coating materials is made in Germany, enhanced anticorrosion in high temperature and humidity.

Low voltage ride-through

- ▶ Derating output when voltage reduced on power grid.

DC generatrix¹

- ▶ DC generatrix operation to reduce the technical influence from instable power supply, and save energy through load sharing.



Woodworking machinery

Welt fitting machine, Tenoning machin, Grooving machine, Carving machine, Sanding machine, CNC machine

Compact Size

- ▶ Subminiature compact design.
- ▶ Side by Side mounting.

Easy Operation

- ▶ LEC panel with same parameter structure, Parameter copy function of 3610 series, easy to use.
- ▶ Structuring parameter convenient to commissioning.

Cost-performance function design

- ▶ 60 seconds last of 150 % rated torque output.
- ▶ Over excitation control to reduce stop time.
- ▶ Standard equipped Modbus RTU.
- ▶ Built-in Mini USB connected with computer for commissioning, parameter copy and software updating.

VFC & EFC 5610 Applications



Metal processing machinery

Lathe, grinder, drill, planer, boring, cold forging

Compact design

- ▶ DIN rail and side by side mounting to save space.

High start torque

- ▶ To meet the process demand of high strength metal cutting, avoid overcurrent and overload during low speed operation .

Quick and dynamic response

- ▶ Accurate speed control for highly smoothness and quality especially for concavo-convex workpiece surface.

Over excitation braking

- ▶ Can help to reduce braking times up to 50 %, without an external break resistor.

Safety Torque off(STO)²

- ▶ Frequency converter false tripping prevent for operation and maintenance safety.



Food and packaging

Conveyor, blow molding, blender, cutter, labeling machines

Quick connectors and DIN rail mounting (up to 7.5 kW)

- ▶ Quick and easy installation and maintenance.

Counter function

- ▶ Built-in Counter to realize the classification and packing of food & drink industry.

Removable control panel

- ▶ Parameter copy function for efficient commissioning of multiple drives.
- ▶ Remote panel support for convenient and safe monitoring and operation.

Integrated sequence control (16 steps)

- ▶ Multi-stage speed control without an additional PLC.



Rubber and plastic machinery

Scroll extruder, pelletizer, bagging machine

Compact design

- ▶ DIN rail mounting (up to 7.5 kW) and side by side mounting (up to 22 kW), to save cabinet space.

High start torque, 200 % at 0.5 Hz

- ▶ To ensure the extruder can start up and operate during the uneven heating temperature environment.

High control accuracy, fast dynamic response

- ▶ Precise control is to ensure the material thickness evenly, in order to save cost and ensure the quality of products.

Torque limit and slip compensation

- ▶ Especially used for constant output torque. Minimize the torque fluctuation and improve the extrusion process quality.

Accessories¹



Mounting plates and panel extension cables²

Mounting plates are used for installing the panel in order to operate and monitor frequency converter without opening control cabinet.

- ▶ Make the hole 85mm(horizontal) * 75mm (vertical) on cabinet door.
- ▶ Remove the panel to install in the mounting plates. Then connect the panel with frequency converter via panel extension cables.
- ▶ Extension cables 2m, 3m, and 5m are available, and the longest operation distance is 5m.



LED/LCD panel²

LED and LCD Panel options of VFC & EFC series.

LED panel

- ▶ Parameter edit and commissioning via LED panel.
- ▶ Real-time display of operating data, fault display and diagnosis maintenance.
- ▶ Parameter copy.

LCD panel

- ▶ Available in Chinese, English, Germany, and other 9 languages.
- ▶ Six line big display screen with backlight, easy to commissioning.
- ▶ Parameter copy.



Bluetooth Adapter²

- ▶ Wireless operation.
- ▶ ConverterWorks APP on Cell or Pad to connect frequency converter for commissioning, firmware update, parameter copy; easy to long-distance commissioning or fault handling directed by experts³.
- ▶ Apply to Android System 4.2 and above.



Brake Chopper¹

The brake chopper is used for consuming electric energy transmitted from external motor to frequency converter and limiting bus voltage within a reasonable range to improve its braking performance and fast stop of the motor.

The brake chopper has standard dust cover, but you can also set the parameters with the use of LED and LCD operating panel of VFC & EFC1 series. It supports the linkage input and linkage output with paralleling up to 3 braking units in maximum. And it also has overvoltage, overcurrent, overheating, short circuit resistance, overheating protection.

- ▶ Operation voltage: 600...785 V, parameter adjusting step size: 0.01 V
- ▶ The length between brake chopper and frequency converter plus the length between brake chopper and brake resistor should not be more than 5m.

Basic wiring mode

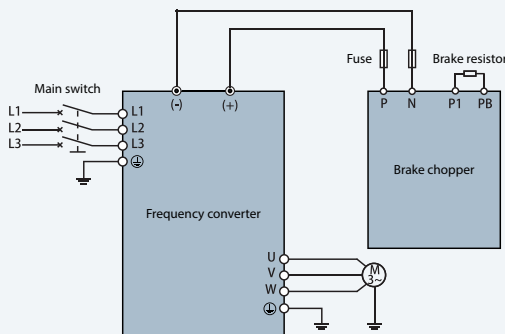

Brake chopper in paralleling wiring mode¹

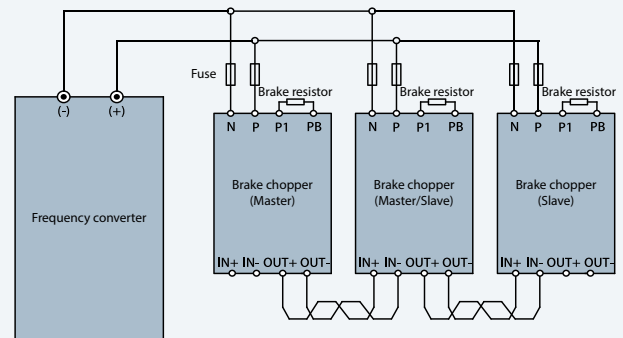

¹: Paralleling wiring mode applies when the capacity of a single brake chopper could not meet the requirement

Brake chopper dimensions

Material Number	Type code	Applicable FC type	W (mm)	H (mm)	D (mm)	w (mm)	h (mm)	d (mm)	
R912007179	FEAE07.1-VA1-NNNN	VFC 5610 30...55 kW	100	215	149	70	205	140	
R912007180	FEAE07.1-VA2-NNNN	VFC 5610 75...90 kW							
R912007181	FEAE07.1-EA1-NNNN	EFC 5610 30...55 kW							
R912007182	FEAE07.1-EA2-NNNN	EFC 5610 75...90 kW							

¹: Only apply to VFC 5610 & EFC 5610

Extension card module

As part of the modular design concept for the VFC & EFC series, the separately available Option Card Module offers the user a variety of customization options, which benefits for operation cost reducing.

The extension card module provides two slots that can be used for a range of extension card module. Cards include an I/O extension card, a multi relay card and various communication extension card module, such as Profibus DP and CANopen.



► Extension Module



► I/O Card



► Multi Relay Card



► PROFIBUS DP Adapter

Please check below table for the possible card combinations.

	Slot 1	Slot 2
Combination 1 [*]	I/O Card	Multi Relay Card
Combination 2 [*]	I/O Card	Communication Card
Combination 3 [*]	Multi Relay Card	Communication Card

^{*} It is not possible to combine 2 extension card modules.

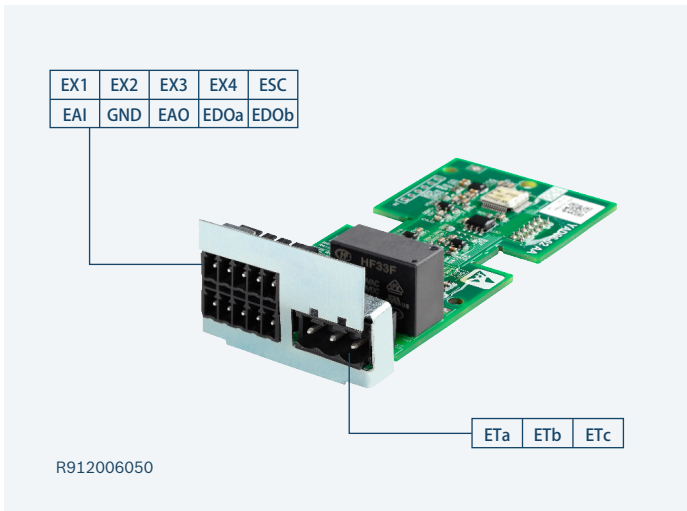

I/O Extension Card

To extend the I/O terminals on VFC & EFC frequency converter, an I/O extension card is available. The maximized I/O points of frequency converter with I/O extension card could be: 9DI, 3AI, 2AO, 2OC, 2 relay output

Terminal	Function	Description
EX1...EX4	4 multi-function digital inputs	24 VDC, 8 mA/12 VDC, 4 mA
EAI1	Analog input	-10...10 V/0(2)...10 V/0(4)...20 mA
EAO1	Analog output	0(2)...10 V/0(4)...20 mA
EDO1	Open collector output	30 VDC, 50 mA
ETa, ETb, ETc	Relay	250 VAC, 3 A/30 VDC, 3 A



Multi Relay Card

The Multi Relay Card offers 4 programmable relay outputs, that can be especially useful in pump and fan control, drive status monitoring or water supply applications.

- ▶ By combining the Multi Relay Card and the I/O Extension Card it is possible to take advantage of up to 6 relays at the same time and save extra wiring cost and installing space.

Terminal	Signal requirement	Description
R1a, R1c, R1b	Rated capacity: 250 VAC, 3 A 30 VDC, 3 A	R1b, R2b, R3b, R4b are relay outputs shared connections
R2a, R2c, R2b		
R3a, R3c, R3b		
R4a, R4c, R4b		



PROFIBUS DP adapter

- ▶ Simple connection
- ▶ Wide installation base, Good compatibility
- ▶ Maximum 127 stations

CANopen adapter

- ▶ Short response time
- ▶ High communication quantity and performance. Reduced EMC problem and cable cost
- ▶ Built-in terminated resistor



Multi-Ethernet Card¹

- ▶ Below communication protocols are supported by Multi-Ethernet Card, which only needs Exchange parameters in frequency converter. PROFINET IO, Ethernet IP, SERCOS III, EtherCAT, Modbus TCP
- ▶ A multi-application card, with which users need only communication protocol switching by setting parameters.

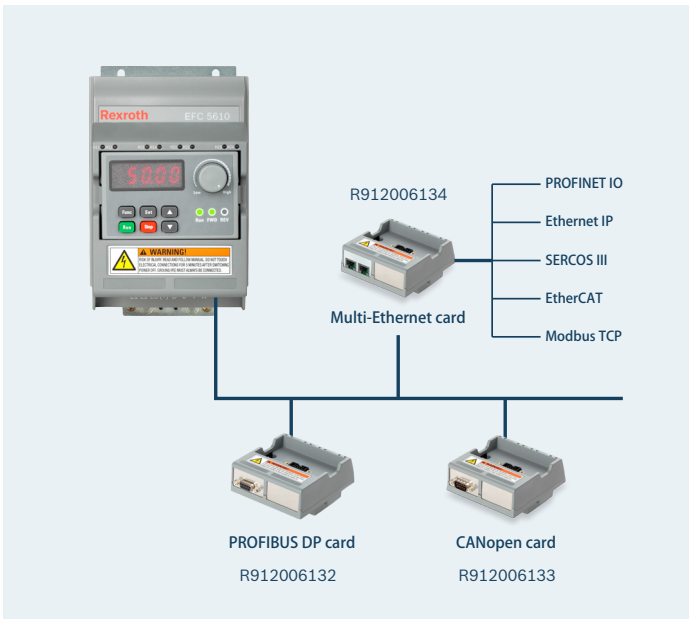

- ▶ EFC series of multifunctional unique options through Ethernet, with greater flexibility and adaptability in the Internet of things. With the BOSCH Rexroth WebConnector² technology. In the near future, the customer to sit in the office or home, intelligent mobile phone monitoring from the inverter operation, storage and analysis of data acquisition, will become a reality

¹: Only apply to EFC series ²: Java based network applications

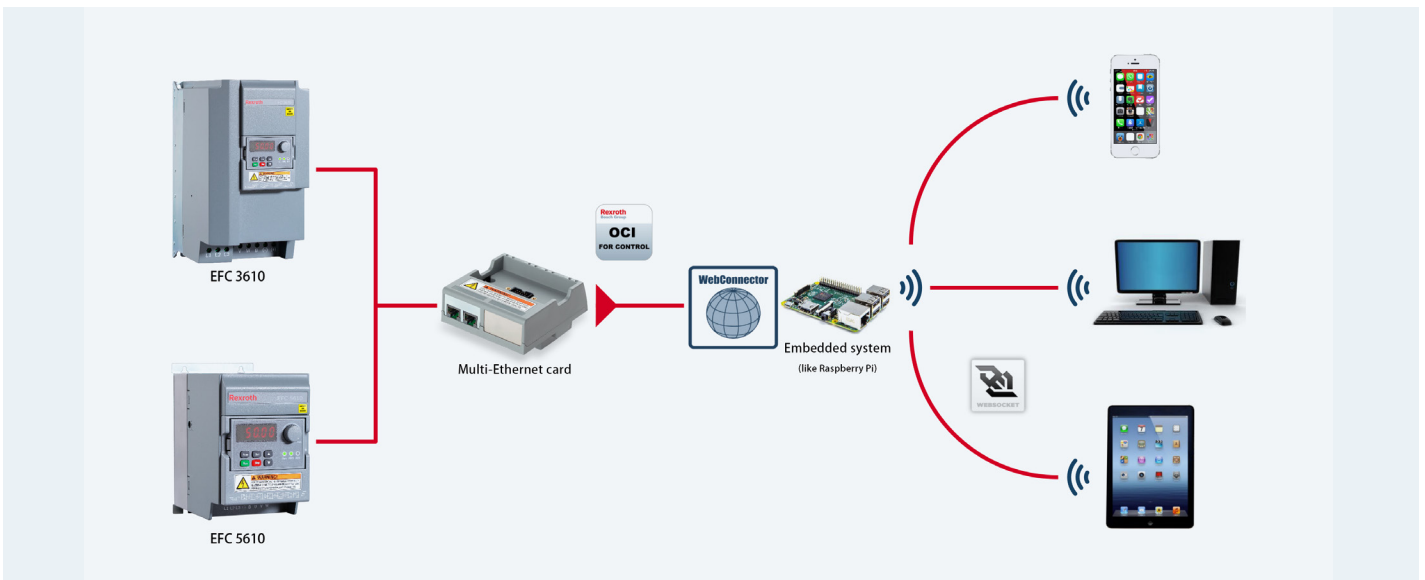

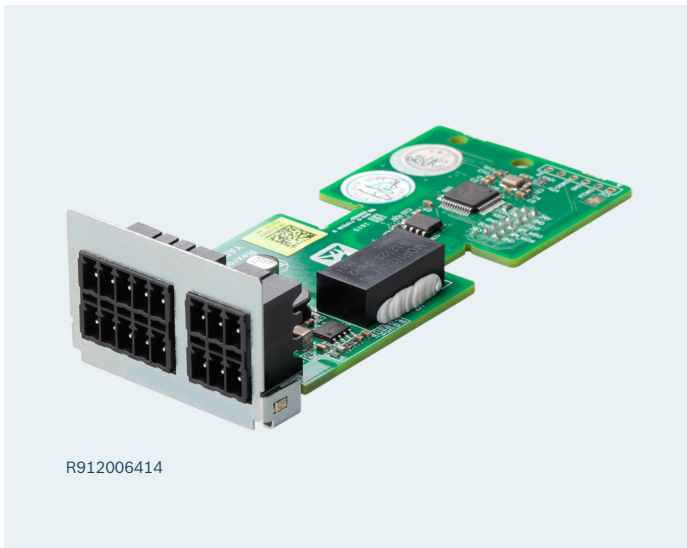

R912006414

ABZ Incremental encoder card

- ▶ It is a standard extension card of Rexroth EFC 5610 series product and should be used together with extension card box
- ▶ It has a variety of voltage levels, which could match the common 5 V encoder and 9...30 V wide voltage encoders in market
- ▶ It supports various encoders, covering the difference, open collector and push-pull type
- ▶ It includes frequency output interface of encoder signal, supporting NPN and PNP output
- ▶ It is extended in the same way like other option cards. And its mounting position is optional

Terminal Description

Interface	Terminal	Signal function	Description ECOM	Signal requirements
Encoder interface	E5V	Encoder power supply 5V	Refer to ECOM	Maximum output current: 200 mA
	E12V	Encoder power supply 12V		Maximum output current: 150 mA
	ECOM	Common port of encoder power supply	GND Isolation	-
	A+	Encoder output signal A+	Refer to ECOM	Input voltage: 5...24 V Maximum input pulse frequency: 300 kHz
	A-	Encoder output signal A-		
	B+	Encoder output signal B+		
	B-	Encoder output signal B-		
	Z+	Encoder output signal Z+		
	Z-	Encoder output signal Z-		
PE	Shielding terminal	Ground radiator terminal connected inside	-	
Pulse output interface	OA	Pulse output A	Refer to GND	Output pulse voltage : 24V Maximum output current: 50 mA
	OB	Pulse output B		
	OZ	Pulse output Z		
	IN24V	External power supply	24V External power supply (non-24V FC terminal power supply) input to OA, OB & OZ	-
	GND	Common port of output pulse	Isolate from ECOM	-
	PE	Shielding terminal	Ground radiator terminal connected inside	-

Cable length

Cable length and section		
Cable length(m)	Cable section	
	AWG	mm ²
10	≤ 24	≥ 0.205
20		
30		
40		
50		
60	≤ 23	≥ 0.258
70		
80		
90	≤ 22	≥ 0.326
100		

Terminal diagram

A+	A-	B+	B-	Z+	OA	OB	OZ
PE	E5V	ECOM	E12V	Z-	GND	IN24V	PE

Technical Data

Encoder power supply	5 V ± 5 % (200 mA) 12 V ± 5 % (150 mA)
Maximum input pulse frequency	300 kHz
Pulse input voltage	5...24 V
Terminal type	Quick connector
Pulse output	1:1 push-pull output

Application Specific Firmware ASF

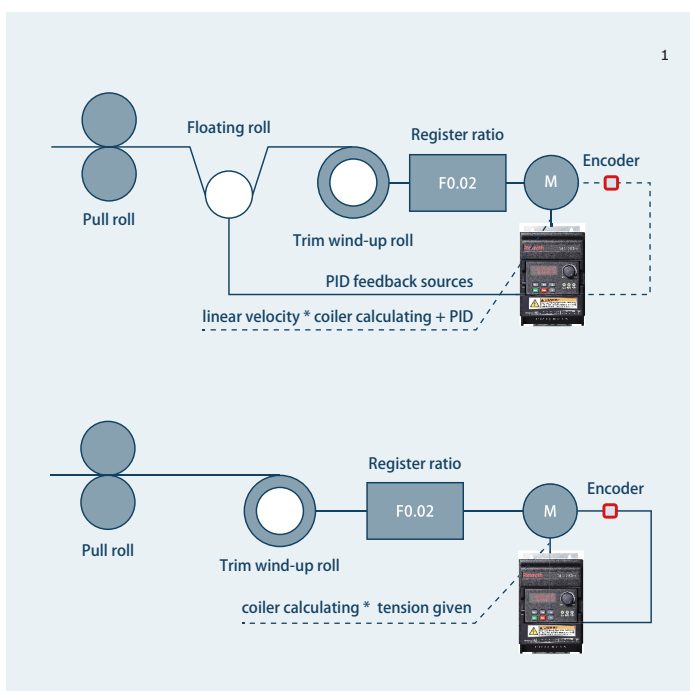

Application Specific Firmware² – Download firmware for different specific applications

- ▶ Different application specific firmware easy for different application demands. (textile, printing, water supply, etc.)
- ▶ Download ASF to frequency converter through USB and ConverterWorks software.
- ▶ Each standard frequency converter could be updated to application specific firmware product via installing ASF.
- ▶ Reducing customer and partner's stock, only standard equipment is fine.

¹: Available in 2017. ²: Please download latest ASF software via www.boschrexroth.com.cn/fc.

PC Software



PC Software¹ - easy commissioning

The Rexroth VFC and EFC frequency converters can be commissioned and operated remotely with the free PC software. The connection to the PC is established via a standard Mini-USB interface.

Parameter Comparison Function

- ▶ Compared adjusted parameter with default parameter, comparison between 2 parameter groups.

Online Commissioning

- ▶ Connected with PC, it is easy to online start-up and stop, parameter revise, and back-up.

Online Monitor Signal

- ▶ Real time monitoring signal data for fast diagnosis and monitoring.

Core Firmware Update¹

- ▶ Core firmware updated via Converterworks software, easy and convenient to get latest function.

Open Platform for flexible applications

According to various of special application demand, and based on standard software of frequency converter, Application Specific Firmware(e.g. water supply ASF) could be downloaded to frequency converter via commissioning software.

- ▶ ASF via frequency converter commissioning software, your frequency converter now available for serving special function request.

¹: Please download latest PC software via www.boschrexroth.com.cn/fc.

For AP region, (Xi'an)
Phone: +86 (29) 86555479 (8:30am-17:10pm / Mon-Fri)
Email: service.fc@boschrexroth.com.cn

For other region, (Lohr)
Tel. +49 9352 40 5060
service.svc@boschrexroth.de

Bosch Rexroth (Xi'an) Electric Drives and Controls Co., Ltd.

No. 3999 Shang Ji Road, Cao Tan Ecology Industry Park,
Economic and Technological Development Zone, 710021,
Xi'an, Shaanxi, P.R.C.
Phone: +86(29)86555 100
Fax: +86(29)86555 106
www.boschrexroth.com
info.fc@boschrexroth.com.cn

R912006023
09/2017A
© Bosch Rexroth China 2016

The data specified above only serve to describe the product. No statements concerning a certain condition or suitability for a certain application can be derived from our information. The information given does not release the user from the obligation of own judgment and verification. It must be remembered that our products are subject to a natural process of wear and aging.

WA HEAD OFFICE

Unit 1 / 45 Inspiration Drive WA 6065
☎ (08) 9303 4966 📠 (08) 9303 4977
✉ info@chainanddrives.com.au

NSW HEAD OFFICE

Unit 7 / 70 Holbeche Road Arndell Park NSW 2148
☎ (02) 9674 8611 📠 (02) 9674 8363
✉ salesnsw@chainanddrives.com.au

www.chainanddrives.com.au